

1 Ton Underhung Motorized End Trucks Single Girder up to 34ft Span 220/440V 3P

Características Esenciales

- I Beam and H Beam Compatible, Customizable up to 12" width Beams
- Kit Includes 2 End Trucks, 4 motors, 4 reducer, 4 Brakes
- Dual Voltage 220/440V 3 Phase, Optional Variable Speed Driver
- Fully Painted Orange RAL2009

Especificaciones Técnicas

Capacidad de Carga	1 ton	Velocidad /min	66 ft
Numero de Velocidades	1 Speed - Optional Variable Speed	Voltaje	3 Phase 240/480V 60Hz
Luz Maxima	50 ft	Material	Steel
Clase de Servicio	H4/M5/2m/Class D	Protección IEC Motor	IP54
Normas	ASME / CMAA / Nch	Garantía	3 Year
Largo de testera	1500 mm		

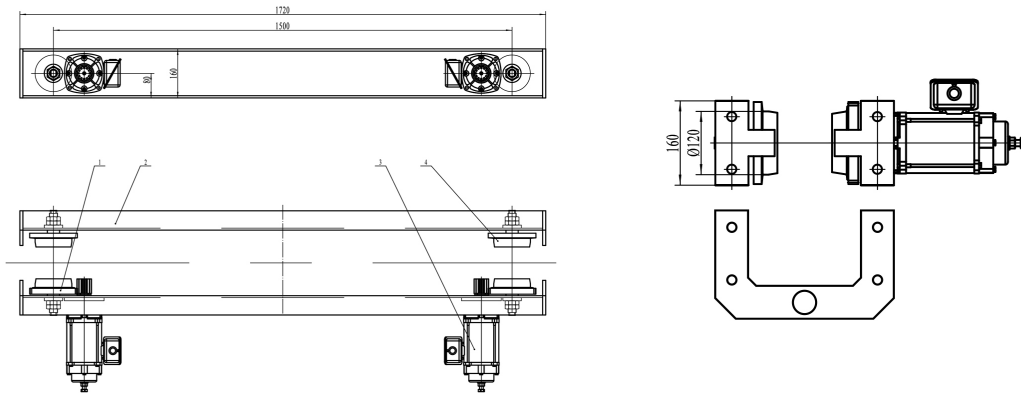

Peso & Dimensiones

Peso Total

596 lbs / 271 Kg

Referential Images / Imágenes Referenciales
Specifications may change without notice / las especificaciones pueden cambiar sin previo aviso