



5 Ton Top Running Motorized End Trucks Single Girder up to 34ft Span 220/440V 3P

Características Esenciales

- For heavy-duty class "C" single girder crane applications
- Drives and brakes are compatible with Variable Frequency Drive (VFD)
- Suitable for use on ASCE crane rail or square bar

Especificaciones Técnicas

Capacidad de Carga	5 Ton	Velocidad /min	66 ft
Numero de Velocidades	1 Speed - Optional Variable Speed	Voltaje	3 Phase 240/480V 60Hz
Luz Maxima	30 Ft	Material	Steel
Clase de Servicio	H4/M5/2m/Class D	Protección IEC Motor	IP54
Normas	ASME / CMAA / Nch	Garantía	3 Year
Largo de testera	1500 mm		

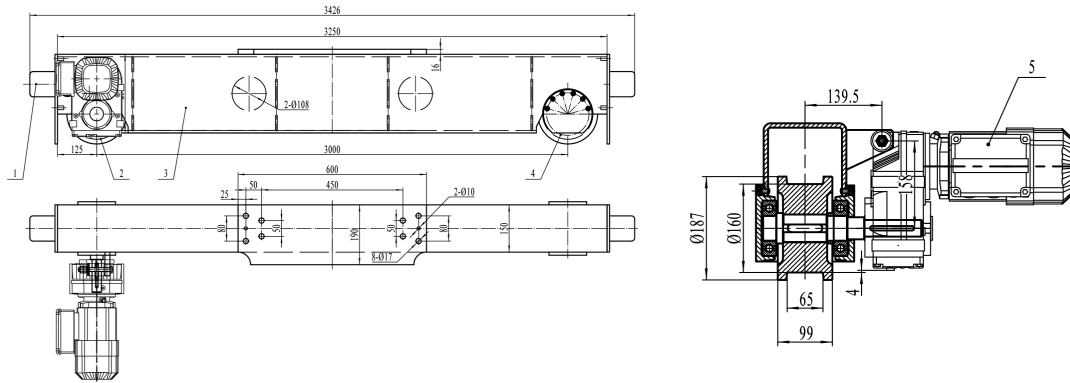

Peso & Dimensiones

Peso Total

895 lbs / 407 Kg

Referential Images / Imágenes Referenciales
Specifications may change without notice / las especificaciones pueden cambiar sin previo aviso