

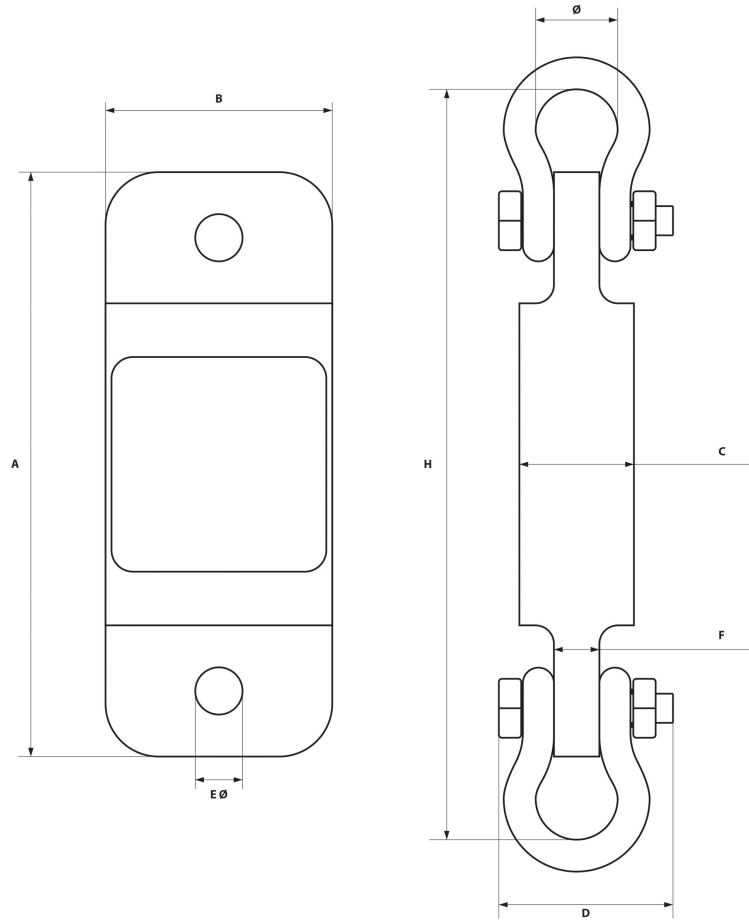

Dinamometro 20 Tons. Aleacion liviana IP67

Especificaciones Técnicas

Scale Accuracy	± 0.3%	Scale Graduations	Alloy
Weighing Units	kg and lb	Temp. Range	-4° to 122°F (-20° to 50°C)
Max Capacity	20 ton	Intervalos de Medición	1/2/5/10/20/50 lb/kg
Frecuencia de Muestro (por seg)	80 times per sec	Peso Mínimo	15 lb
Balance Cero	±1% FS, TCO = ±0.05% FS 50 °F / 10 °C	Factor de Diseño	4:1
Garantía	3 Year		



Model / Modelo	PWHYCS1T	PWHYCS5T	PWHTCS10T	PWHYCS20T	PWHYCS30T	PWHYCS50T
A	9 5/8 in	11 1/4 in	12 1/3 in	16.5 in	16.5 in	18.3 in
	244.5 mm	286 mm	318 mm	420 mm	420 mm	465 mm
B	3 3/4 in	4 in	4 1/2 in	4.8 in	5.4 in	5.9 in
	95.3 mm	102 mm	114 mm	128 mm	138 mm	150 mm
C	1 7/8 in	2 in	1 7/8 in	2.8 in	3.1 in	3.9 in
	47.6 mm	51 mm	48 mm	70 mm	80 mm	100 mm
D	2 13/16 in	4 7/8 in	6 1/2 in	10.2 in	11 in	12 in
	71.4 mm	124 mm	165 mm	260 mm	280 mm	305 mm
Ø	1 3/8 in	2 1/4 in	3 1/4 in	5 in	5.7 in	7.2 in
	34.9 mm	57 mm	83 mm	127 mm	146 mm	184 mm
H	12 in	16 in	19 1/2 in	25.9 in	29.1 in	36.6 in
	304.8 mm	406 mm	495 mm	660 mm	740 mm	930 mm
EØ	13/16 in	1 7/16 in	1 7/6 in			
	19.6 mm	37 mm	37 mm			
F	3/4 in	1 3/8 in	1 7/8 in			
	19.04 mm	35 mm	48 mm			

Peso & Dimensiones

Peso Total

44 lbs / 20 Kg

Referential Images / Imágenes Referenciales

Specifications may change without notice / las especificaciones pueden cambiar sin previo aviso